

# DC224-6B DATA SHEET



## DC224-6B

224AH@20HR

6-Volt

DEEP CYCLE

Maintenance-Free  
Sealed AGM Battery

### Nominal Specifications

Battery Model	DC224-6B	Rated Capacity	224AH/20HR
---------------	----------	----------------	------------

### Mechanical Specifications

Group Size	GC2	
Overall Height (H)	267±2mm	10.51"
Container Height (h)	245±2mm	9.65"
Length	260±2mm	10.24"
Width	180±2mm	7.09"
Weight	Approx.30.9kg	68.12lbs.
Terminal Type	M8-Button Terminal	
Terminal Torque	9.6-10.7N.m	
Container Material	ABS: Standard (UL 94-HB)	

### Temperature Range Specifications

Operating Temperature Range	Discharge : -15°C ~+ 50°C (5°F ~122°F)
	Charge: -15°C ~ +40°C (5°F ~104°F)
	Storage: -15°C ~ +40°C (5°F ~104°F)
Recommended Operating Temperature Range	+74°F (23°C) to +80°F (27°C)
Self-Discharge	Less than 10% after 90 days, can be stored up to 6 months at 25°C (77°F); Fully recharging is required before usage, For higher temperatures the time interval will be shorter.

### Electrical Specifications

C100	246AH
C20	224AH
C10	194AH
C5	179AH
CCA	1025A
CA or MCA	1230A
HPCA	1470A
Max. Discharge Current	2200A (5s)
Internal Resistance	1.1mΩ
Reserve Capacity	
Reserve @25 AMPS	441Minutes
Reserve @75 AMPS	113Minutes

### Charge Voltages

Float Charging Voltage	6.75 to 6.90 VDC/unit@ (25°C)	
Equalization and Cycle Service Charging Voltage	7.15 to 7.25 VDC/unit @ (25°C)	
Maximum Charge Current(A)	55A	
Charging Temperature Compensation	Cycle use	-4mV/cell/°C
	Float use	-3mV/cell/°C

### BATTERY & TERMINAL DIMENSIONS (All units shown in mm)

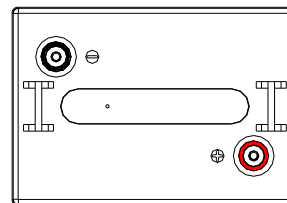
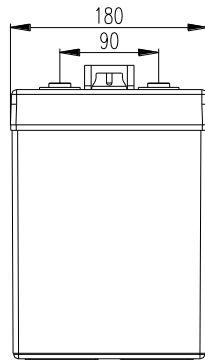
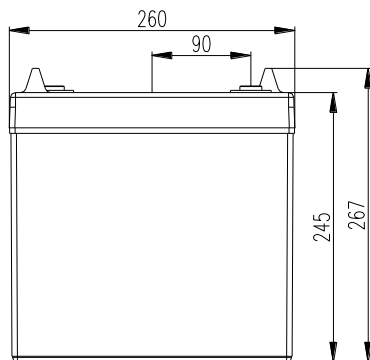

Battery bank spacing required 12.5mm (1/2"inch) minimum

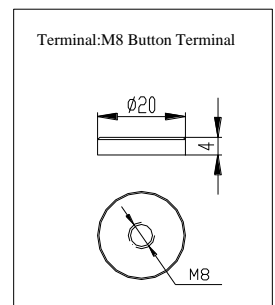

### Constant Current Discharge Rating Amperes @ 77°F (25°C)

Cut off voltage V/cell	15M	30M	45M	1H	2H	3H	5H	8H	10H	12H	20H
1.75V	315	197.6	148	116	66.1	48.9	34.2	23.5	19.4	16.6	11.2

**Note** The above data are average values, and can be obtained with 3 charge/discharge cycles. These are not minimum values.



# DC224-6B DATA SHEET

## Terminal Voltage(V) and Discharge Time

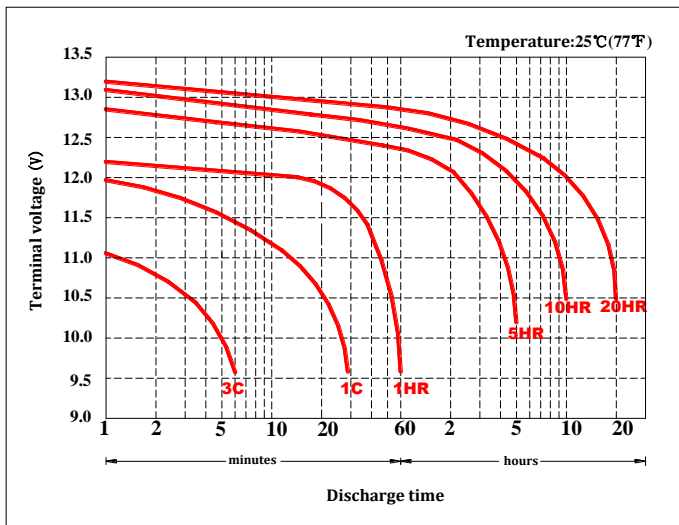

## Duration of discharge vs. Discharge current

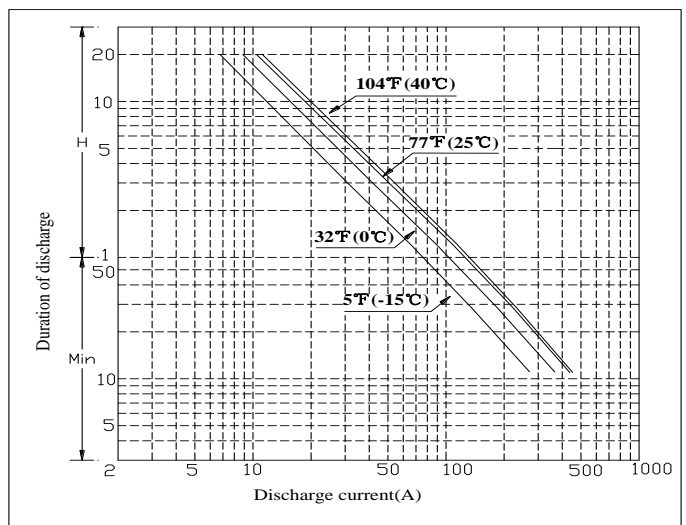

## Percent Capacity vs. Temperature

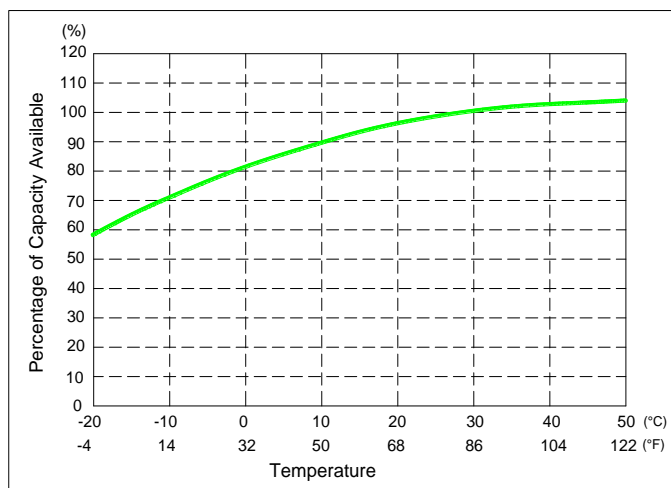

## State of Charge(SOC) vs Open Circuit Voltage(OCV)

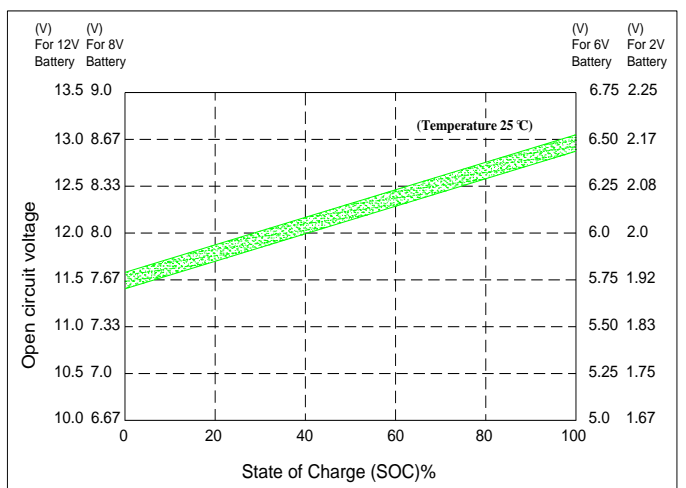

## Capacity Retention Characteristic

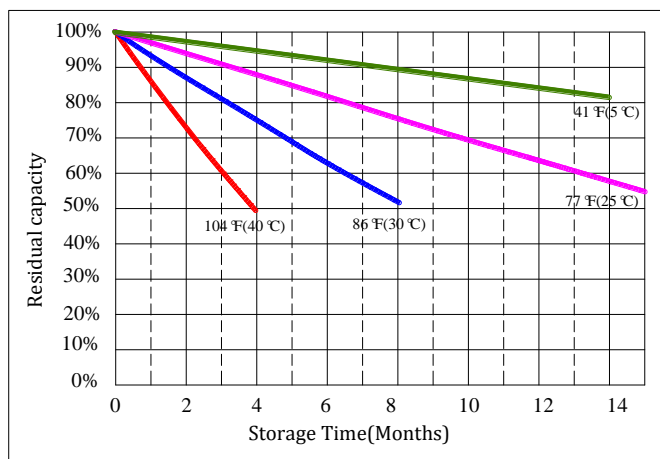

## Cycle Life vs. Depth of Discharge(DOD)

