

DC120-12A DATA SHEET



DC120-12A

120AH@20HR

12-Volt

DEEP CYCLE

Maintenance-Free
Sealed AGM Battery

Nominal Specifications

Battery Model	DC120-12A	Rated Capacity	120AH/20HR
---------------	-----------	----------------	------------

Mechanical Specifications

Group Size	N/A	
Overall Height (H)	240±2mm	9.45"
Container Height (h)	210±2mm	8.27"
Length	407±2mm	16.02"
Width	174±2mm	6.85"
Weight	Approx.37.6kg	82.89lbs.
Terminal Type	M8- Button Terminal	
Terminal Torque	9.6-10.7 N.m	
Container Material	ABS Standard UL 94-HB	

Electrical Specifications

C100	132AH
C20	120AH
C10	108AH
C5	98AH
CCA	750A
CA or MCA	900A
HPCA	1080A
Max. Discharge Current	1200A (5s)
Internal Resistance	3.3mΩ
Reserve Capacity	
Reserve @25 AMPS	223Minutes
Reserve @75 AMPS	52 Minutes

Temperature Range Specifications

Operating Temperature Range	Discharge: -15 ~ +50 (5 ~ 122 °F)
	Charge: -15 ~ +40 (5 ~ 104 °F)
	Storage: -15 ~ +40 (5 ~ 104 °F)
Recommended Operating Temperature Range	+74 °F (23 °C) to +80 °F (27 °C)
Self-Discharge	Less than 10% after 90 days, can be stored up to 6 months at 25 (77 °F); Fully recharging is required before usage, For higher temperatures the time interval will be shorter.

Charge Voltages

Float Charging Voltage	13.5 to 13.8 VDC/unit @ (25°C)	
Equalization and Cycle Service Charging Voltage	14.3 to 14.5 VDC/unit @ (25°C)	
Maximum Charge Current(A)	30A	
Charging Temperature Compensation	Cycle use	-4mV/cell/°C
	Float use	-3mV/cell/°C

BATTERY & TERMINAL DIMENSIONS (All units shown in mm)

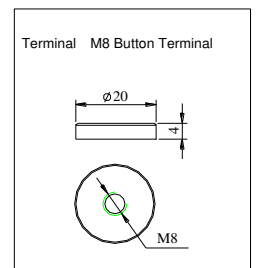
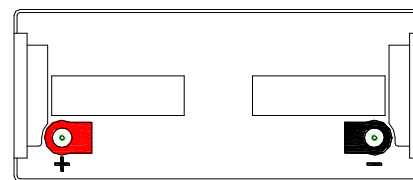
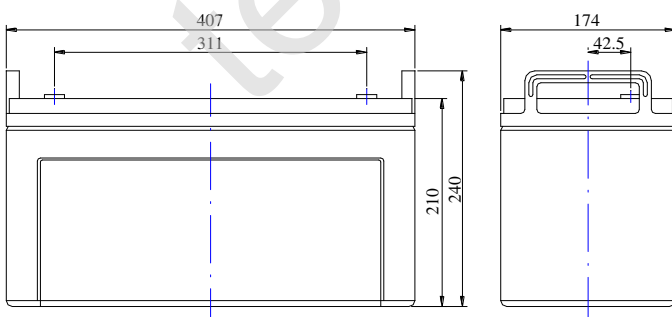

Constant Current Discharge Rating Amperes @ 77 °F (25 °C)

Cut off voltage V/cell	15M	30M	45M	1H	2H	3H	5H	8H	10H	12H	20H
1.75V	174	112	83	68.2	36.1	27.2	19.0	13.1	10.80	9.20	6.00

Note The above data are average values, and can be obtained with 3 charge/discharge cycles. These are not minimum values.



DC120-12A DATA SHEET

Terminal Voltage(V) and Discharge Time

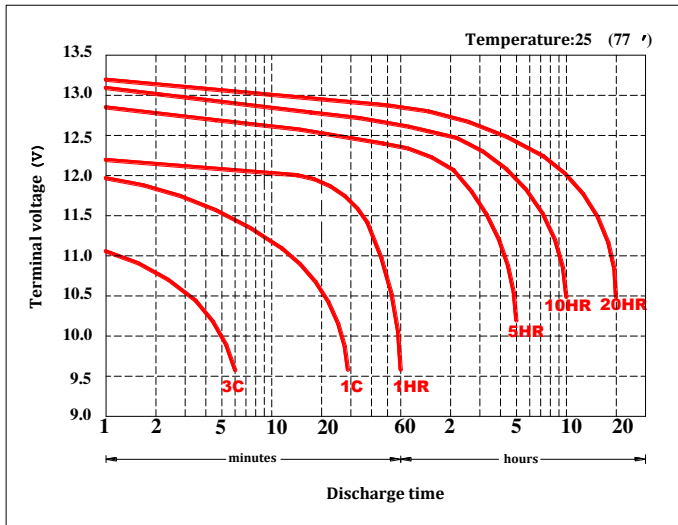

Duration of discharge vs. Discharge current

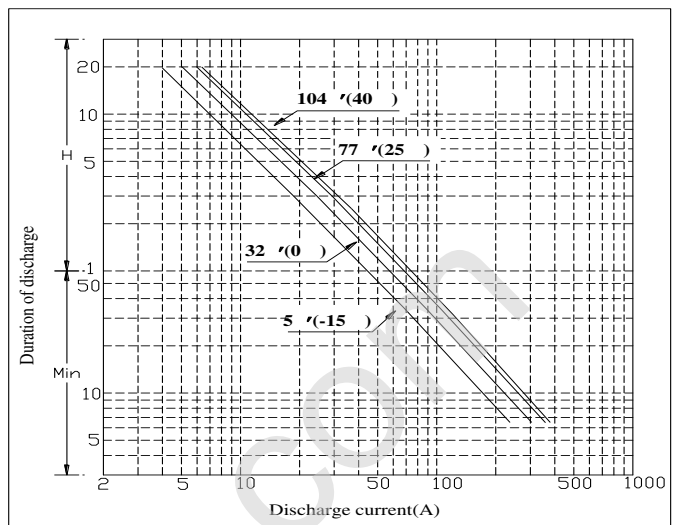

Percent Capacity vs. Temperature

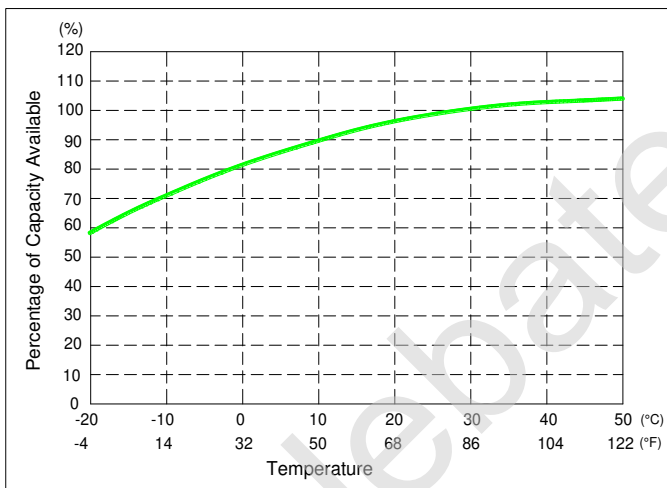

State of Charge(SOC) vs Open Circuit Voltage(OCV)

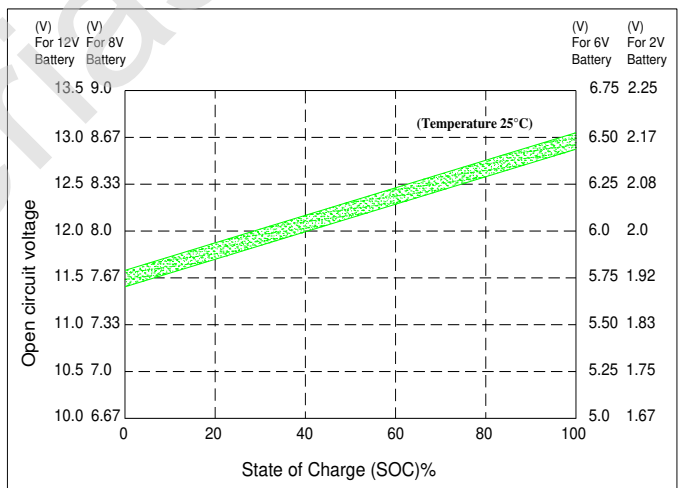

Capacity Retention Characteristic

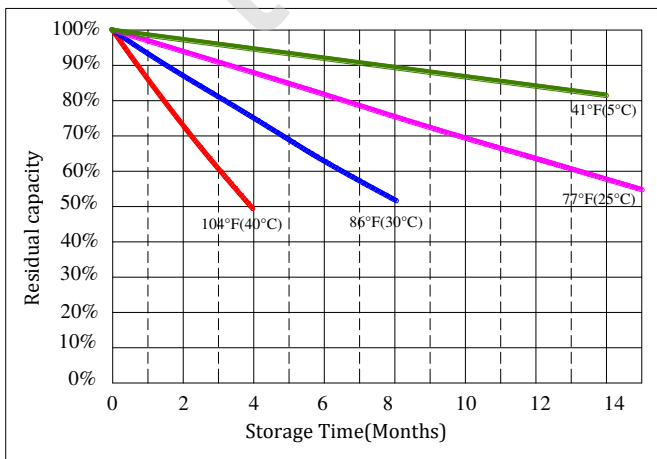

Cycle Life vs. Depth of Discharge(DOD)

