

DC160-8A DATA SHEET



DC160-8A

160AH@20HR

8-Volt

DEEP CYCLE

Maintenance-Free
Sealed AGM Battery

Nominal Specifications

Battery Model	DC160-8A	Rated Capacity	160AH/20HR
---------------	----------	----------------	------------

Mechanical Specifications

Group Size	GC8	
Overall Height (H)	272±2mm	10.71"
Container Height (h)	268±2mm	10.55"
Length	260±2mm	10.24"
Width	182±2mm	7.17"
Weight	Approx.32.3kg	71.21lbs.
Terminal Type	M8-Button Terminal	
Terminal Torque	9.6-10.7N.m	
Container Material	ABS Standard UL 94-HB	

Electrical Specifications

C100	178AH
C20	160AH
C10	144AH
C5	131AH
CCA	900A
CA or MCA	1080A
HPCA	1290A
Max. Discharge Current	1600A (5s)
Internal Resistance	2.0 mΩ
Reserve Capacity	
Reserve @25 AMPS	325 Minutes
Reserve @56 AMPS	120 Minutes

Temperature Range Specifications

Operating Temperature Range	Discharge: -15 ~ +50 (5 ~ 122 °F)
	Charge: -15 ~ +40 (5 ~ 104 °F)
	Storage: -15 ~ +40 (5 ~ 104 °F)
Recommended Operating Temperature Range	+74 °F (23 °C) to +80 °F (27 °C)
Self-Discharge	Less than 10% after 90 days, can be stored up to 6 months at 25 (77 °F); Fully recharging is required before usage, For higher temperatures the time interval will be shorter.

Charge Voltages

Float Charging Voltage	9.0 to 9.2 VDC/unit @ (25°C)	
Equalization and Cycle Service Charging Voltage	9.53 to 9.67 VDC/unit @ (25°C)	
Maximum Charge Current(A)	40 A	
Charging Temperature Compensation	Cycle use	-4mV/cell/
	Float use	-3mV/cell/

BATTERY & TERMINAL DIMENSIONS (All units shown in mm)

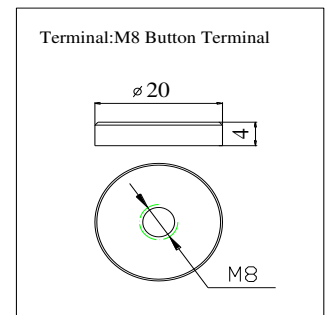
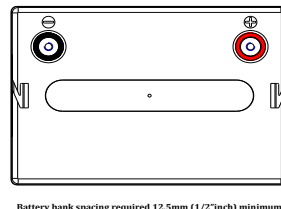
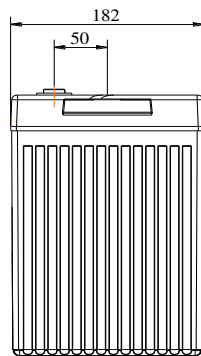
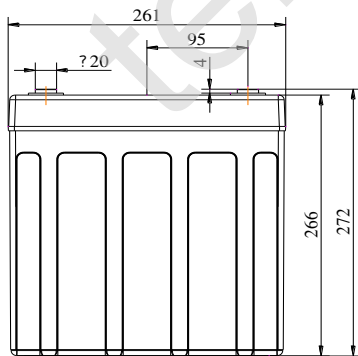

Constant Current Discharge Rating Amperes @ 77 °F (25 °C)

Cut off voltage V/cell	15M	30M	45M	1H	2H	3H	5H	8H	10H	12H	20H
1.75V	232	150	110	90.2	56.1	39.2	25.7	17.4	14.4	12.3	8.0

Note The above data are average values, and can be obtained with 3 charge/discharge cycles. These are not minimum values.



DC160-8A DATA SHEET

Terminal Voltage(V) and Discharge Time

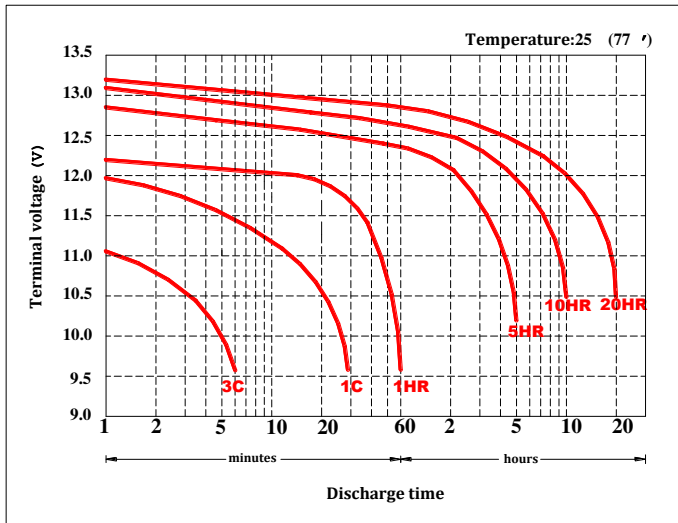

Duration of discharge vs. Discharge current

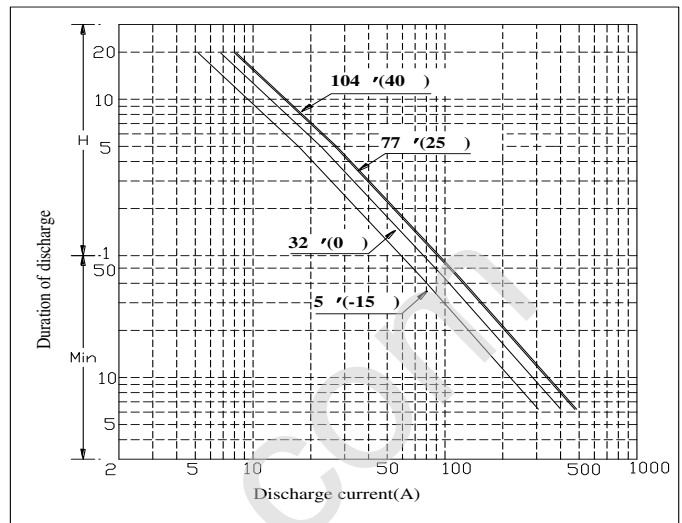

Percent Capacity vs. Temperature

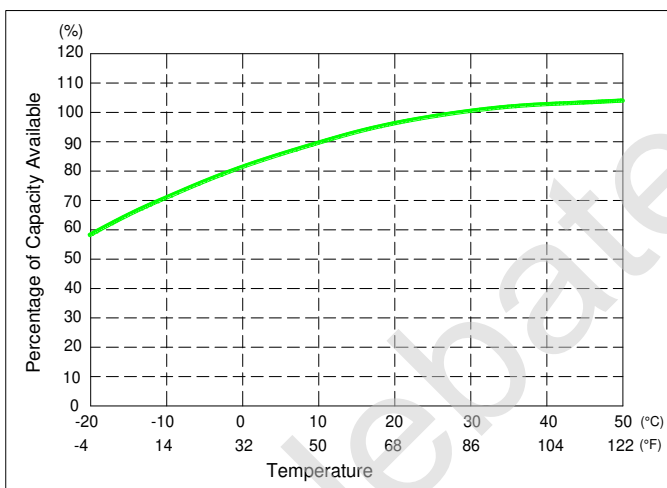

State of Charge(SOC) vs Open Circuit Voltage(OCV)

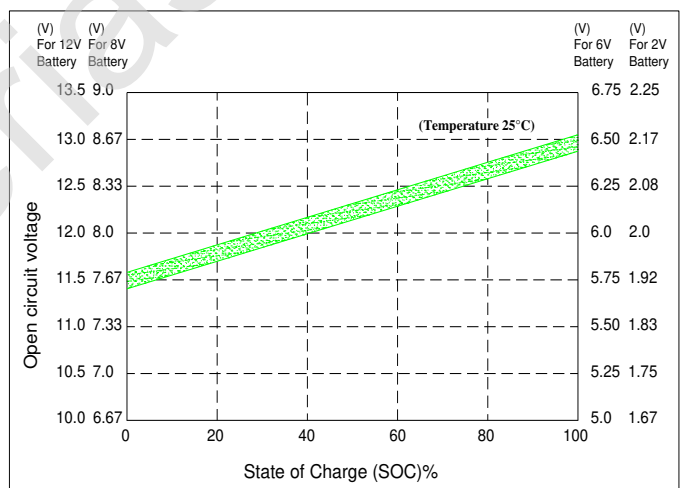

Capacity Retention Characteristic

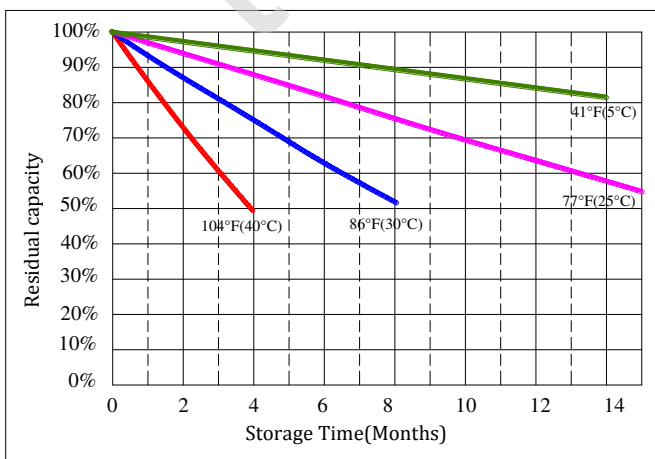

Cycle Life vs. Depth of Discharge(DOD)

