

MODEL **SAGM 12 135**
 VOLTAGE **12**
 CAPACITY **135Ah @ 20Hr**
 MATERIAL **Polypropylene**
 BATTERY **VRLA AGM / Non-Spillable / Maintenance-Free**
 COLOR **Maroon**
 WATERING **No Watering Required**
 IEC 61427 **8+ Years Life**



12 VOLT

PHYSICAL SPECIFICATIONS

| MODEL NAME | TERMINAL TYPE ^D | DIMENSIONS ^B INCHES (mm) | | | WEIGHT ^F LBS. (kg) | HANDLES | INSTALLATION ORIENTATION |
|-------------|----------------------------|-------------------------------------|------------|---------------------|-------------------------------|----------|--------------------------|
| | | LENGTH | WIDTH | HEIGHT ^C | | | |
| SAGM 12 135 | M8/LT | | | | 83 (38) | Embedded | Horizontal and Vertical |
| | | 12.96 (329) | 7.06 (179) | 10.96 (278) | | | |

ELECTRICAL SPECIFICATIONS

| VOLTAGE | CAPACITY ^A AMP-HOURS (Ah) | | | | | ENERGY (kWh) | INTERNAL RESISTANCE (mΩ) | SHORT CIRCUIT CURRENT (amps) |
|---------|--------------------------------------|-------|-------|-------|--------|--------------|--------------------------|------------------------------|
| | 10-Hr | 20-Hr | 48-Hr | 72-Hr | 100-Hr | | | |
| 12 | | | | | | 20-Hr | 4.3 | 2920 |
| | 131 | 135 | 136 | 137 | 137 | 1.62 | | |

CHARGING INSTRUCTIONS

| CHARGER VOLTAGE SETTINGS (AT 77°F/25°C) | | | | |
|---|------------------------|-------|-------|-------|
| SYSTEM VOLTAGE | 12V | 24V | 36V | 48V |
| Maximum Charge Current (A) | 20% of C ₂₀ | | | |
| Absorption Voltage (2.40 V/cell) | 14.40 | 28.80 | 43.20 | 57.60 |
| Float Voltage (2.25 V/cell) | 13.50 | 27.00 | 40.50 | 54.00 |

Do not install or charge batteries in a sealed or non-ventilated compartment. Constant under or overcharging will damage the battery and shorten its life as with any battery.

CHARGING TEMPERATURE COMPENSATION

| ADD | SUBTRACT |
|---|---|
| 0.005 volt per cell for every 1°C below 25°C 0.0028 volt per cell for every 1°F below 77°F | 0.005 volt per cell for every 1°C above 25°C 0.0028 volt per cell for every 1°F above 77°F |

OPERATIONAL DATA

| OPERATING TEMPERATURE | SELF DISCHARGE |
|---|---|
| -4°F to 122°F (-20°C to +50°C). At temperatures below 32°F (0°C) maintain a state of charge greater than 60%. | Less than 3% per month depending on storage temperature conditions. |

RECYCLE RESPONSIBLY



STATE OF CHARGE MEASURE OF OPEN-CIRCUIT VOLTAGE

| PERCENTAGE CHARGE | CELL | 12 VOLT |
|-------------------|------|---------|
| 100 | 2.14 | 12.84 |
| 75 | 2.09 | 12.54 |
| 50 | 2.04 | 12.24 |
| 25 | 1.99 | 11.94 |
| 0 | 1.94 | 11.64 |

SOLAR CYCLE-LIFE

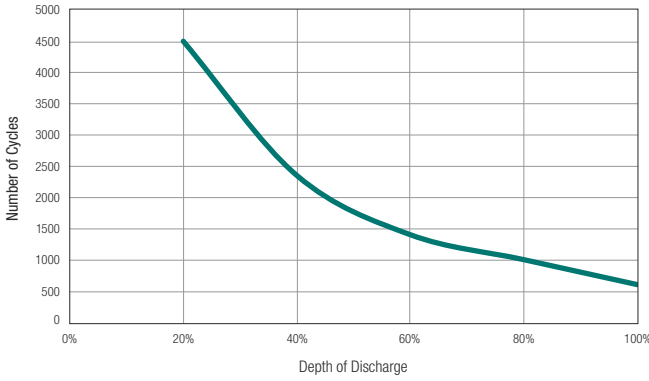

PERCENT CAPACITY VS. TEMPERATURE

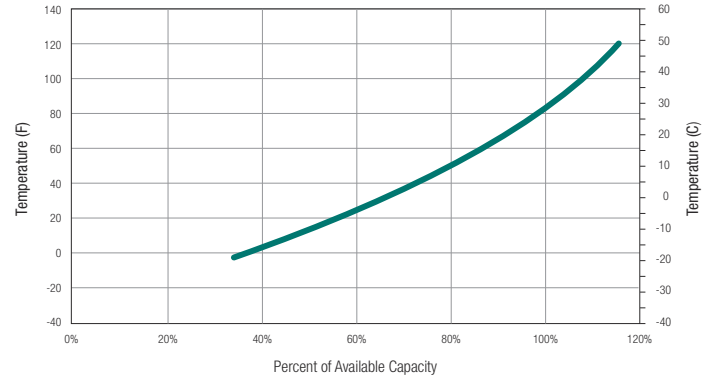

SELF DISCHARGE VS. TIME^E

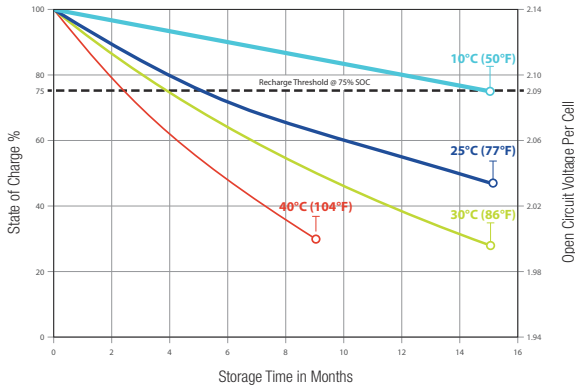

TROJAN SAGM 12 135 PERFORMANCE

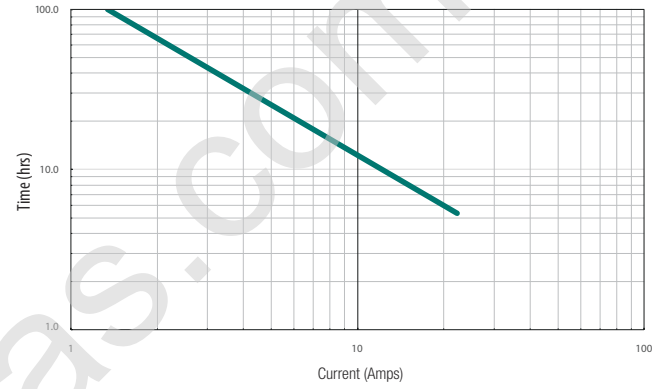

BATTERY DIMENSIONS (shown with M8, height is 12.07 (307) with LT)

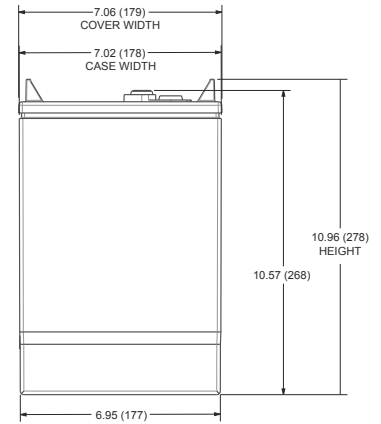
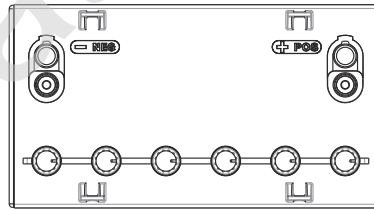
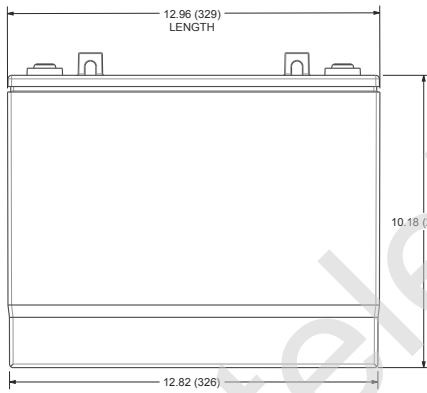

TERMINAL CONFIGURATIONS^D

| 15 | M8 | M8 |
|----|---|--|
| | Battery Height with Terminal in Inches (mm) 10.57 (268) | Torque Values in-lb (Nm) Bolt: 85 – 90 (10 – 11) |

| 15 | M8 | M8 WITH LT ADAPTER (ADAPTER PROVIDED BUT NOT INSTALLED) |
|----|---|---|
| | Battery Height with Terminal in Inches (mm) 12.07 (307) | Torque Values in-lb (Nm) Connection to M8: 85 – 90 (10 – 11) Connection to LT: 65 – 75 (7.5 – 8.5) |
| | Bolt Size M8 x 1.25 | |

- A. The amount of amp-hours (Ah) a battery can deliver when discharged at a constant rate at 86°F (30°C) for all rates and maintain a voltage above 1.75 V/cell. Capacities are based on peak performance.
- B. Dimensions may vary depending on type of handle or terminal. Batteries should be mounted with 0.5 inches (12.7 mm) spacing minimum.

- C. Height taken from bottom of the battery to the highest point on the battery. Heights may vary depending on type of terminal.
- D. Terminal images are representative only.
- E. A boost charge should be performed every 6 months when batteries are in storage.
- F. Weight may vary.



Designed in compliance with applicable BCI, DIN, BS and IEC standards.
Tested in compliance to BCI and IEC standards.

800.423.6569 / +1.562.236.3000 / trojanbattery.com

SAGM_12_135_DS_021319



© 2019 Trojan Battery Company, LLC. All rights reserved. Trojan Battery Company is not liable for damages that may result from any information provided in or omitted from this publication, under any circumstances. Trojan Battery Company reserves the right to make adjustments to this publication at any time, without notice or obligation.