



DC145-12

145AH@20HR

12-Volt

DEEP CYCLE

**Maintenance-Free
Sealed AGM Battery**

Nominal Specifications

Battery Model	DC145-12	Rated Capacity	145AH/20HR
---------------	----------	----------------	------------

Mechanical Specifications

Group Size	N/A		
Overall Height (H)	287±2mm	11.30"	
Container Height (h)	281±2mm	11.06"	
Length	341±2mm	13.43"	
Width	173±2mm	6.81"	
Weight	Approx.43.5kg	95.90lbs.	
Terminal Type	M8- Button Terminal		
Terminal Torque	9.6-10.7 N.m		
Container Material	ABS Standard "UL 94-HB "		

Electrical Specifications

C100	160AH
C20	145AH
C10	131AH
C5	122AH
CCA	820A
CA or MCA	975A
HPCA	1170A
Max. Discharge Current	1450A (5s)
Internal Resistance	3.5mΩ
Reserve Capacity	
Reserve @25 AMPS	279Minutes
Reserve @75 AMPS	86Minutes

Temperature Range Specifications

Operating Temperature Range	Discharge : -15 ~+50 (5 ~122 °)
	Charge: -15 ~+40 (5 ~104 °)
	Storage: -15 ~+40 (5 ~104 °)
Recommended Operating Temperature Range	+74 °(23 °) to +80 °(27 °)
Self-Discharge	Less than 10% after 90 days, can be stored up to 6 months at 25 (77 °); Fully recharging is required before usage, For higher temperatures the time interval will be shorter.

Charge Voltages

Float Charging Voltage	13.5 to 13.8 VDC/unit@ (25°C)	
Equalization and Cycle Service Charging Voltage	14.3 to 14.5 VDC/unit @(25°C)	
Maximum Charge Current(A)	40A	
Charging Temperature Compensation	Cycle use	-4mV/cell/
	Float use	-3mV/cell/

BATTERY & TERMINAL DIMENSIONS (All units shown in mm)

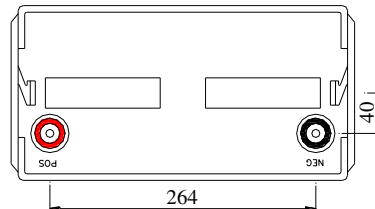
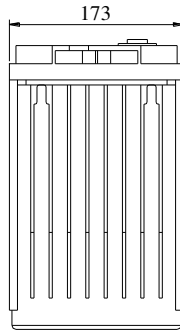
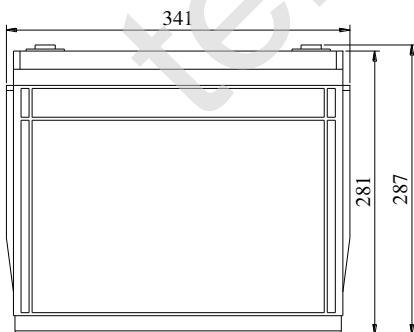

Battery bank spacing required 12.5mm (1/2"inch) minimum

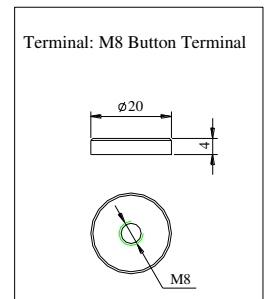

Constant Current Discharge Rating Amperes @ 77 °(25 °)

Cut off voltage V/cell	15M	30M	45M	1H	2H	3H	5H	8H	10H	12H	20H
1.75V	232	135.3	99.9	82.4	43.7	32.9	23	15.8	13.1	11.1	7.25

Note The above data are average values, and can be obtained with 3 charge/discharge cycles. These are not minimum values.



DC145-12 DATA SHEET

Terminal Voltage(V) and Discharge Time

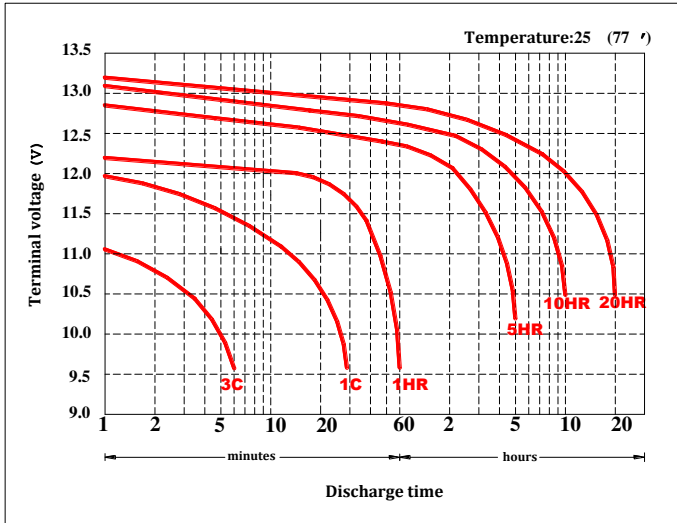

Duration of discharge vs. Discharge current

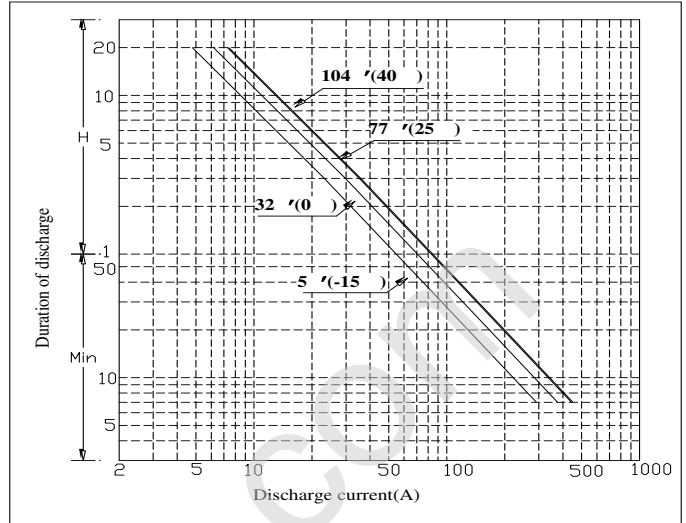

Percent Capacity vs. Temperature

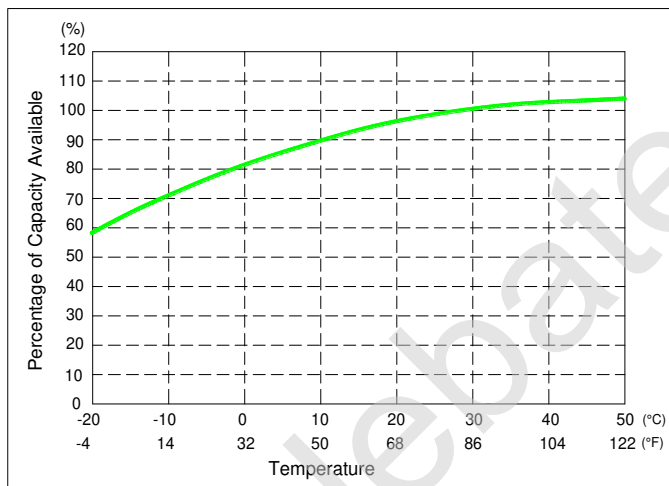

State of Charge(SOC) vs Open Circuit Voltage(OCV)

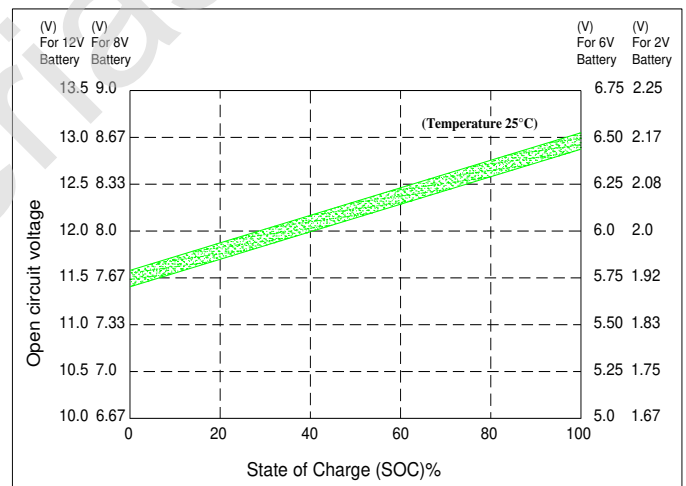

Capacity Retention Characteristic

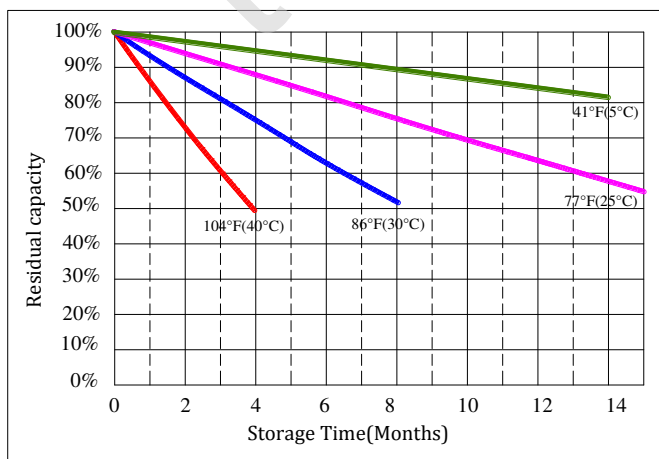

Cycle Life vs. Depth of Discharge(DOD)

