

DC224-6B DATA SHEET



DC224-6B

224AH@20HR

6-Volt

DEEP CYCLE

Maintenance-Free
Sealed AGM Battery

Nominal Specifications

Battery Model	DC224-6B	Rated Capacity	224AH/20HR
---------------	----------	----------------	------------

Mechanical Specifications

Group Size	GC2	
Overall Height (H)	267±2mm	10.51"
Container Height (h)	245±2mm	9.65"
Length	260±2mm	10.24"
Width	180±2mm	7.09"
Weight	Approx.30.9kg	68.12lbs.
Terminal Type	M8-Button Terminal	
Terminal Torque	9.6-10.7N.m	
Container Material	ABS Standard UL 94-HB	

Electrical Specifications

C100	246AH
C20	224AH
C10	194AH
C5	179AH
CCA	1025A
CA or MCA	1230A
HPCA	1470A
Max. Discharge Current	2200A (5s)
Internal Resistance	1.1mΩ
Reserve Capacity	
Reserve @25 AMPS	441Minutes
Reserve @75 AMPS	113Minutes

Temperature Range Specifications

Operating Temperature Range	Discharge: -15 ~ +50 (5 ~ 122 °F)
	Charge: -15 ~ +40 (5 ~ 104 °F)
	Storage: -15 ~ +40 (5 ~ 104 °F)
Recommended Operating Temperature Range	+74 °F (23 °C) to +80 °F (27 °C)
Self-Discharge	Less than 10% after 90 days, can be stored up to 6 months at 25 (77 °F); Fully recharging is required before usage, For higher temperatures the time interval will be shorter.

Charge Voltages

Float Charging Voltage	6.75 to 6.90 VDC/unit @ (25°C)	
Equalization and Cycle Service Charging Voltage	7.15 to 7.25 VDC/unit @ (25°C)	
Maximum Charge Current(A)	55A	
Charging Temperature Compensation	Cycle use	-4mV/cell/
	Float use	-3mV/cell/

BATTERY & TERMINAL DIMENSIONS (All units shown in mm)

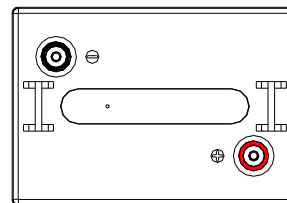
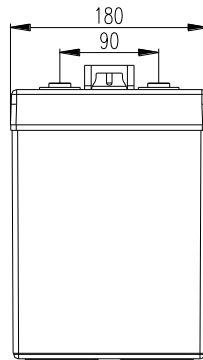
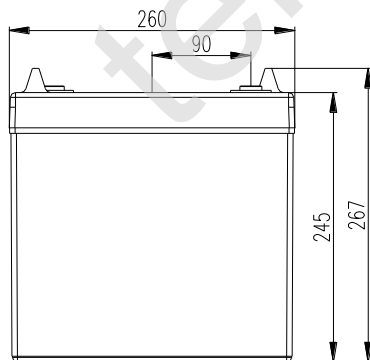

Battery bank spacing required 12.5mm (1/2"inch) minimum

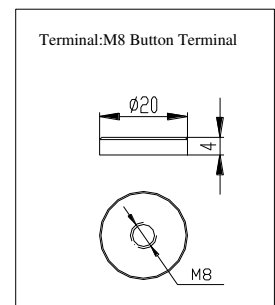

Constant Current Discharge Rating Amperes @ 77 °F (25 °C)

Cut off voltage V/cell	15M	30M	45M	1H	2H	3H	5H	8H	10H	12H	20H
1.75V	315	197.6	148	116	66.1	48.9	34.2	23.5	19.4	16.6	11.2

Note The above data are average values, and can be obtained with 3 charge/discharge cycles. These are not minimum values.



DC224-6B DATA SHEET

Terminal Voltage(V) and Discharge Time

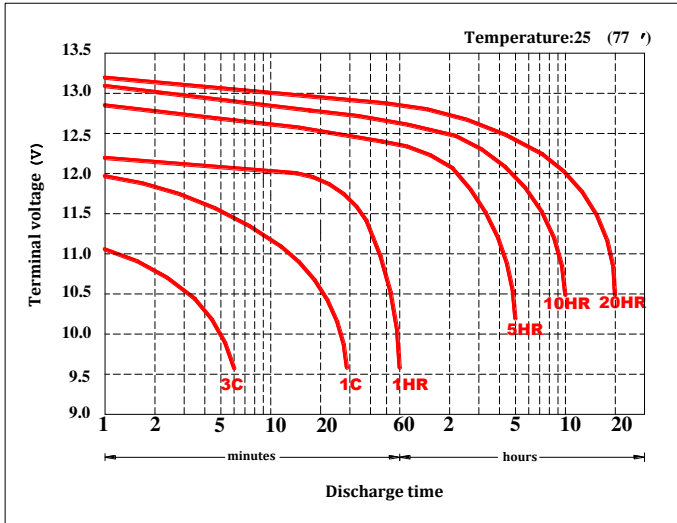

Duration of discharge vs. Discharge current

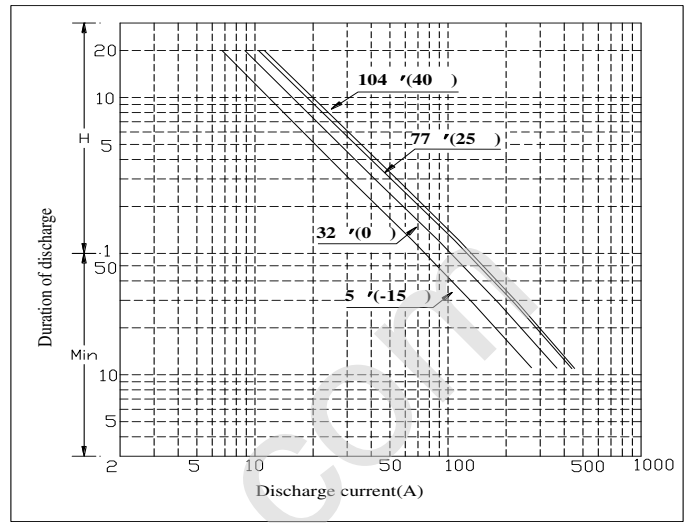

Percent Capacity vs. Temperature

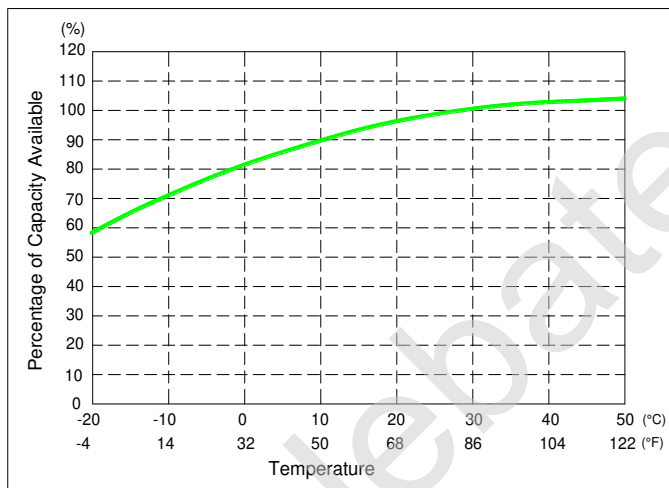

State of Charge(SOC) vs Open Circuit Voltage(OCV)

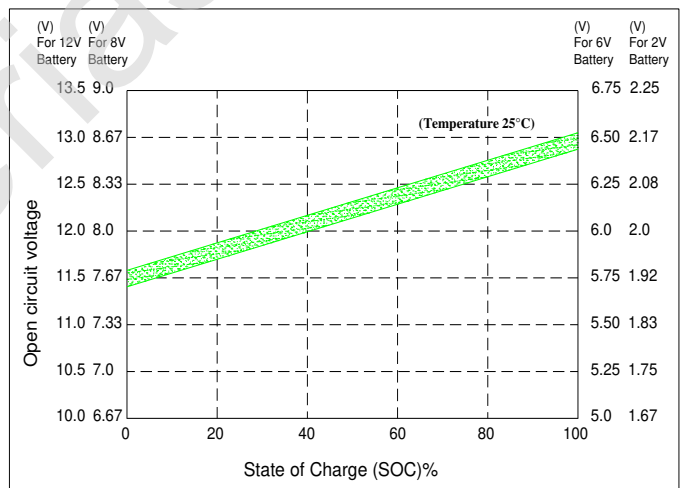

Capacity Retention Characteristic

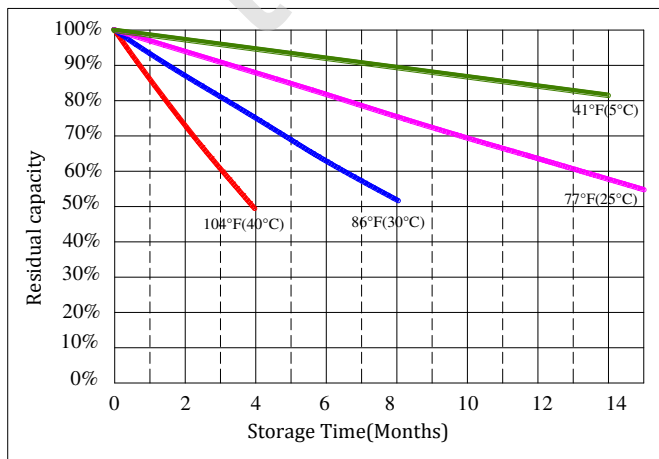

Cycle Life vs. Depth of Discharge(DOD)

