

DC60-12B DATA SHEET



DC60-12B

60AH@20HR

12-Volt

DEEP CYCLE

Maintenance-Free
Sealed AGM Battery

Nominal Specifications			
Battery Model	DC60-12B	Rated Capacity	60AH/20HR
Mechanical Specifications			
Group Size	48		
Overall Height (H)	190±2mm	7.48"	
Container Height (h)	190±2mm	7.48"	
Length	278±2mm	10.94"	
Width	175±2mm	6.89"	
Weight	Approx.22kg	48.50lbs.	
Terminal Type	AP- Auto Post Terminal		
Terminal Torque	5.6-7.9 N.m		
Container Material	ABS Standard UL 94-HB		

Electrical Specifications	
C100	66AH
C20	60AH
C10	54AH
C5	49.2AH
CCA	510A
CA or MCA	670A
HPCA	800A
Max. Discharge Current	900A (5s)
Internal Resistance	4.5mΩ
Reserve Capacity	
Reserve @25 AMPS	105 Minutes
Reserve @75 AMPS	24 Minutes

Temperature Range Specifications	
Operating Temperature Range	Discharge: -15 ~ +50 (5 ~122 °)
	Charge: -15 ~ +40 (5 ~104 °)
	Storage: -15 ~ +40 (5 ~104 °)
Recommended Operating Temperature Range	+74 °(23 °) to +80 °(27 °)
Self-Discharge	Less than 10% after 90 days, can be stored up to 6 months at 25 (77 °); Fully recharging is required before usage, For higher temperatures the time interval will be shorter.

Charge Voltages		
Float Charging Voltage	13.5 to 13.8 VDC/unit@ (25°C)	
Equalization and Cycle Service Charging Voltage	14.3 to 14.5 VDC/unit @ (25°C)	
Maximum Charge Current(A)	15A	
Charging Temperature Compensation	Cycle use	-4mV/cell/
	Float use	-3mV/cell/

BATTERY & TERMINAL DIMENSIONS (All units shown in mm)

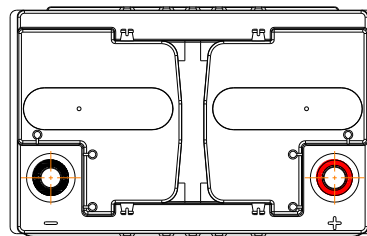
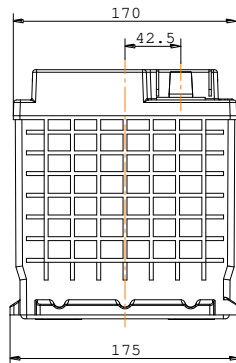
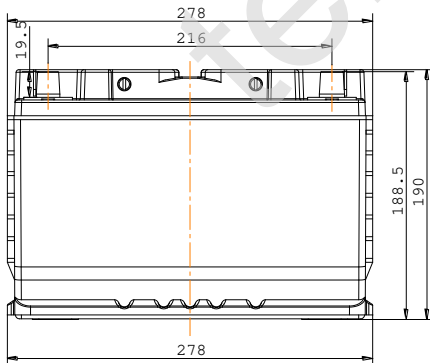

Battery bank spacing required 12.5mm (1/2"inch) minimum

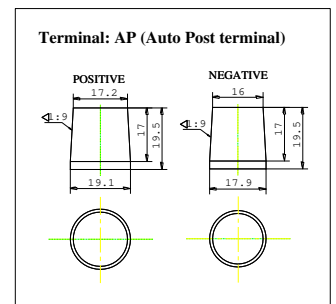

Constant Current Discharge Rating Amperes @ 77 °(25 °)

Cut off voltage V/cell	15M	30M	45M	1H	2H	3H	5H	8H	10H	12H	20H
1.75V	105	63	45	33.6	21.5	14.2	9.64	6.50	5.40	4.60	3.00

Note The above data are average values, and can be obtained with 3 charge/discharge cycles. These are not minimum values.



DC60-12B DATA SHEET

Terminal Voltage(V) and Discharge Time

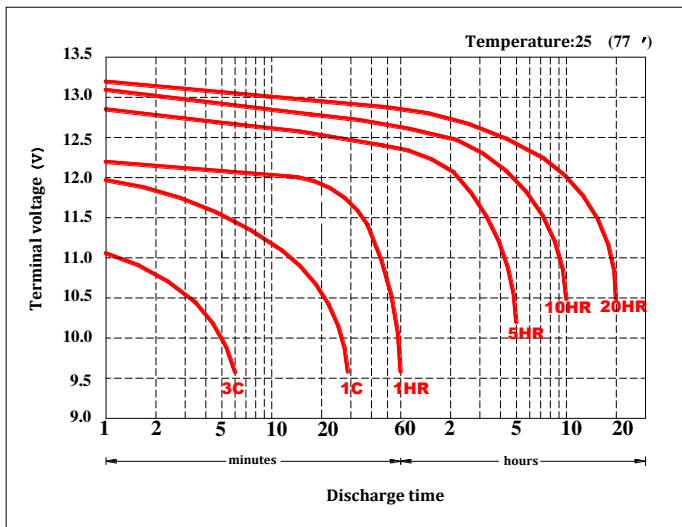

Duration of discharge vs. Discharge current

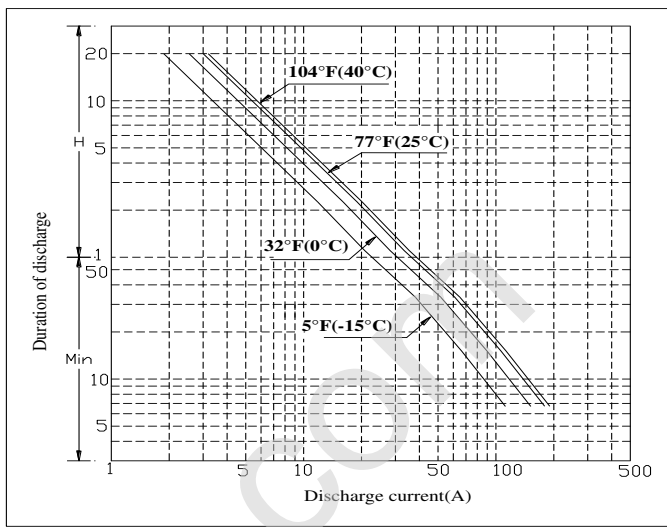

Percent Capacity vs. Temperature

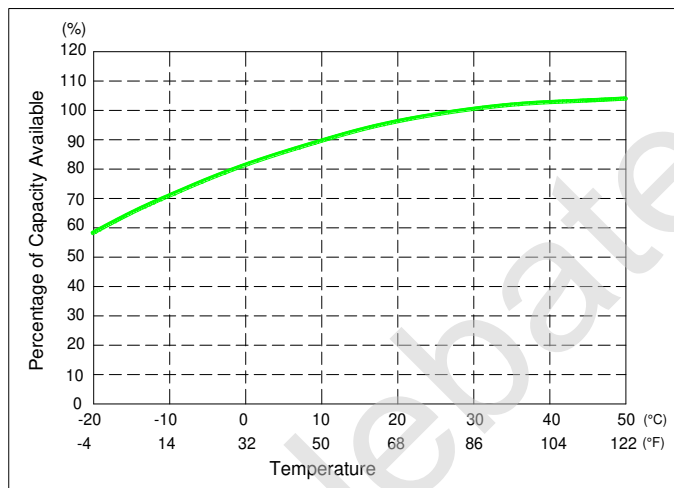

State of Charge(SOC) vs Open Circuit Voltage(OCV)

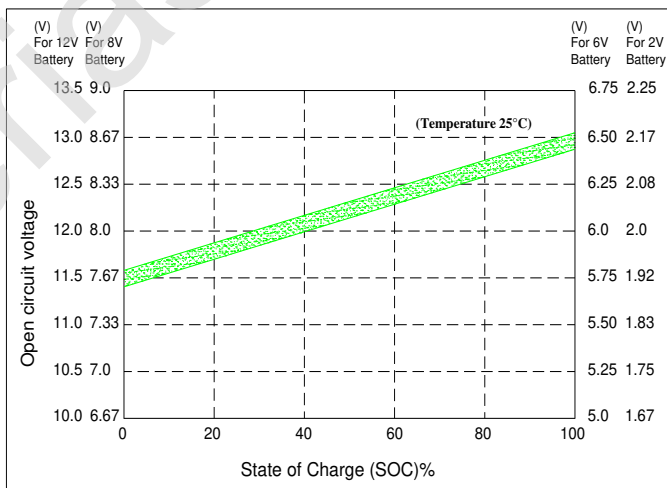

Capacity Retention Characteristic

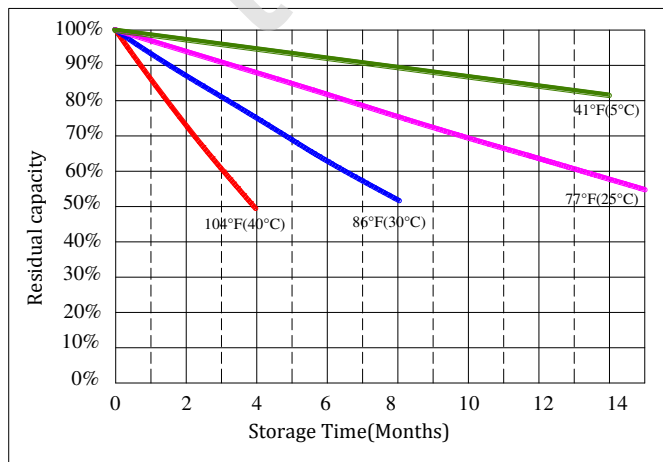

Cycle Life vs. Depth of Discharge(DOD)

